

DH 90-1

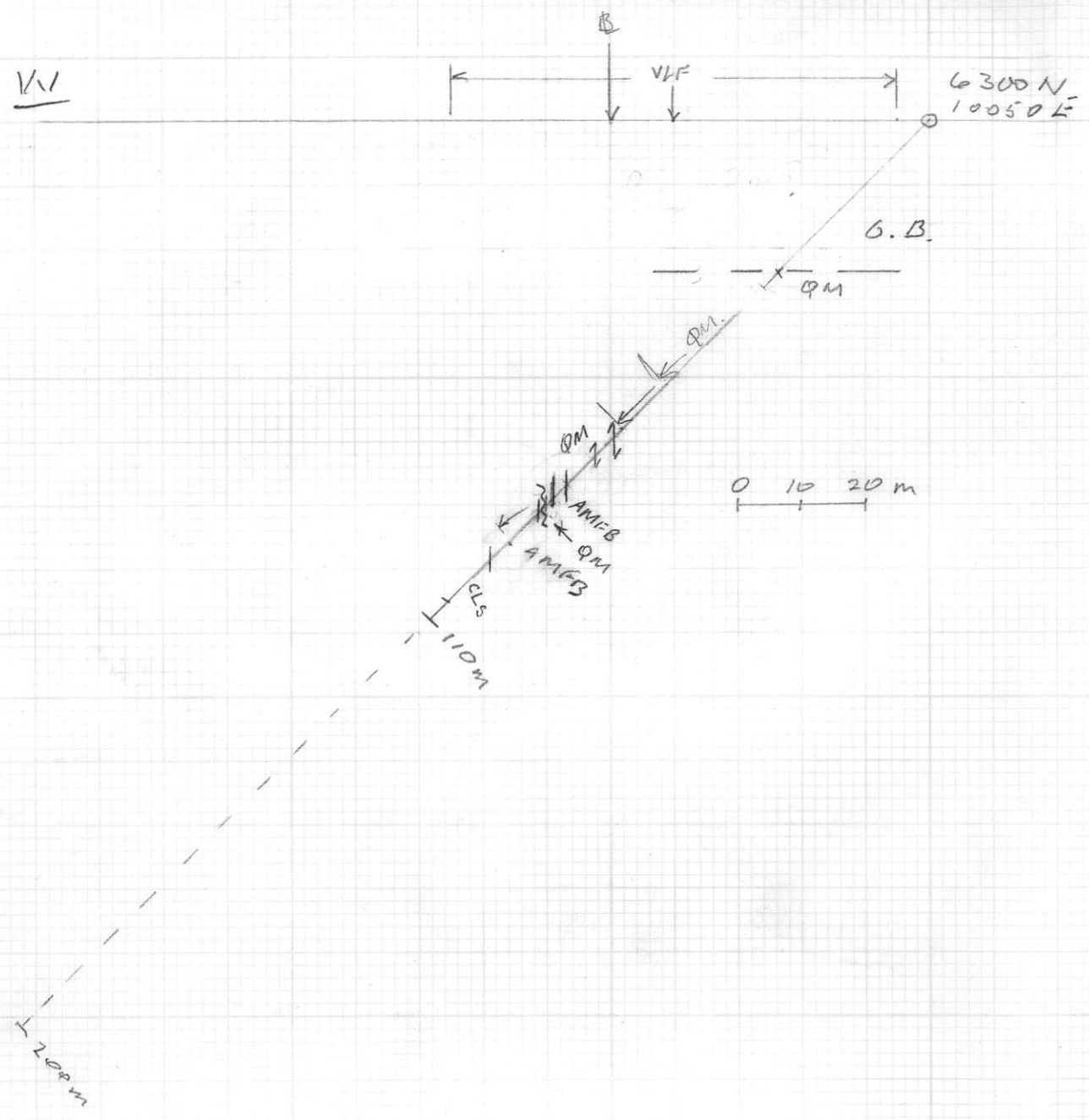

E

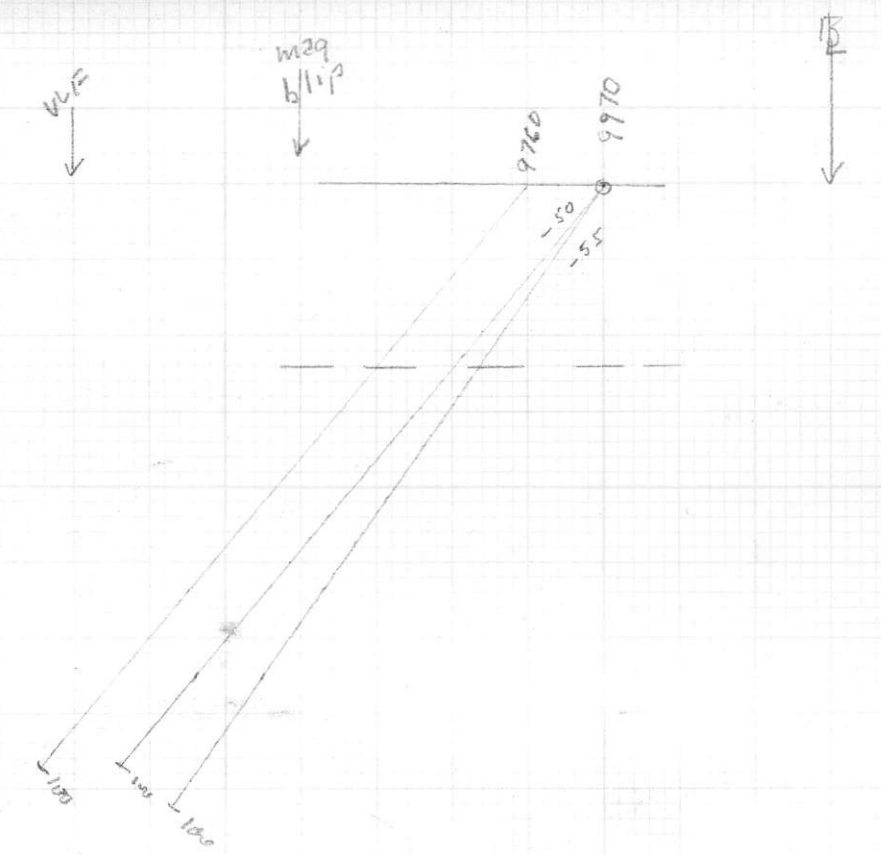

DH 90-2

W

E

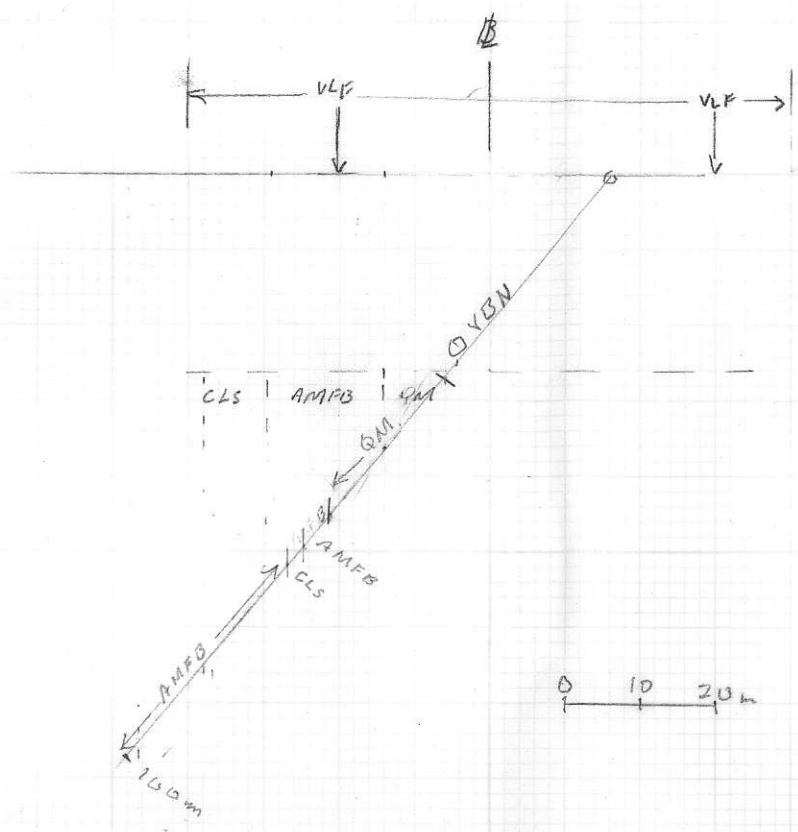

165N

60° B 10000
 50° B 10016E

0 10 20 m

150m

W

DH 90-3

E

VLIF
↓

↓

Approx
6742N
10,000E @ -50°, Brg-233°



O.B.

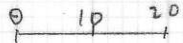
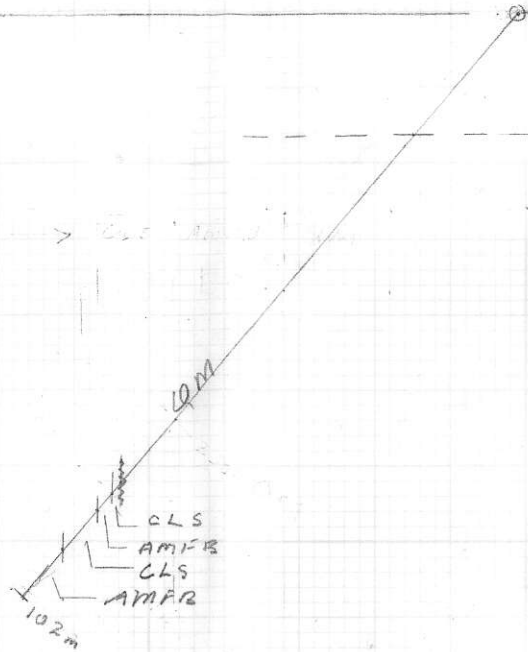

6700

6600

6500

6400

6300

6200

6100

6000

10,000 E

0

111 QM

111 QM

QM 111

111 QM

→ SRE

VLF

Scale 1:2000

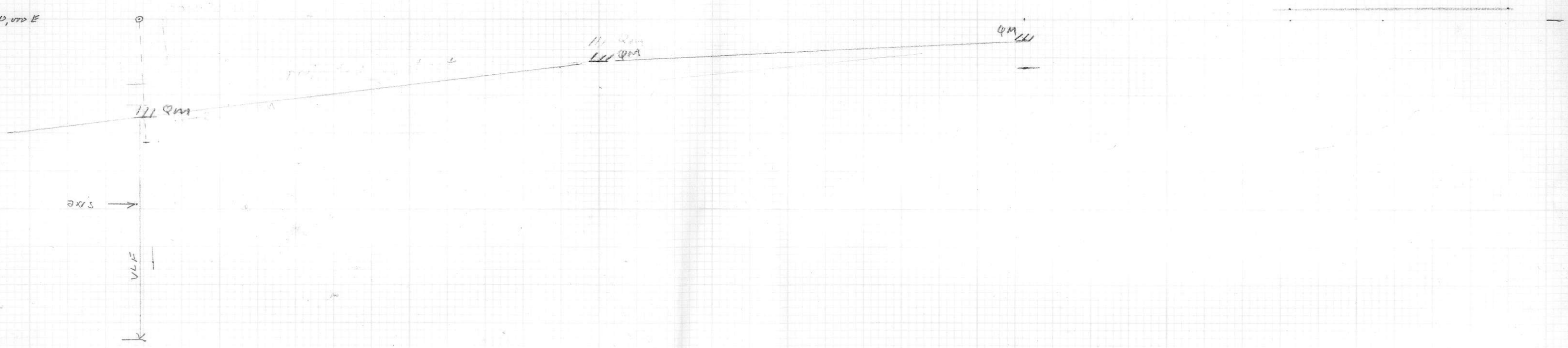

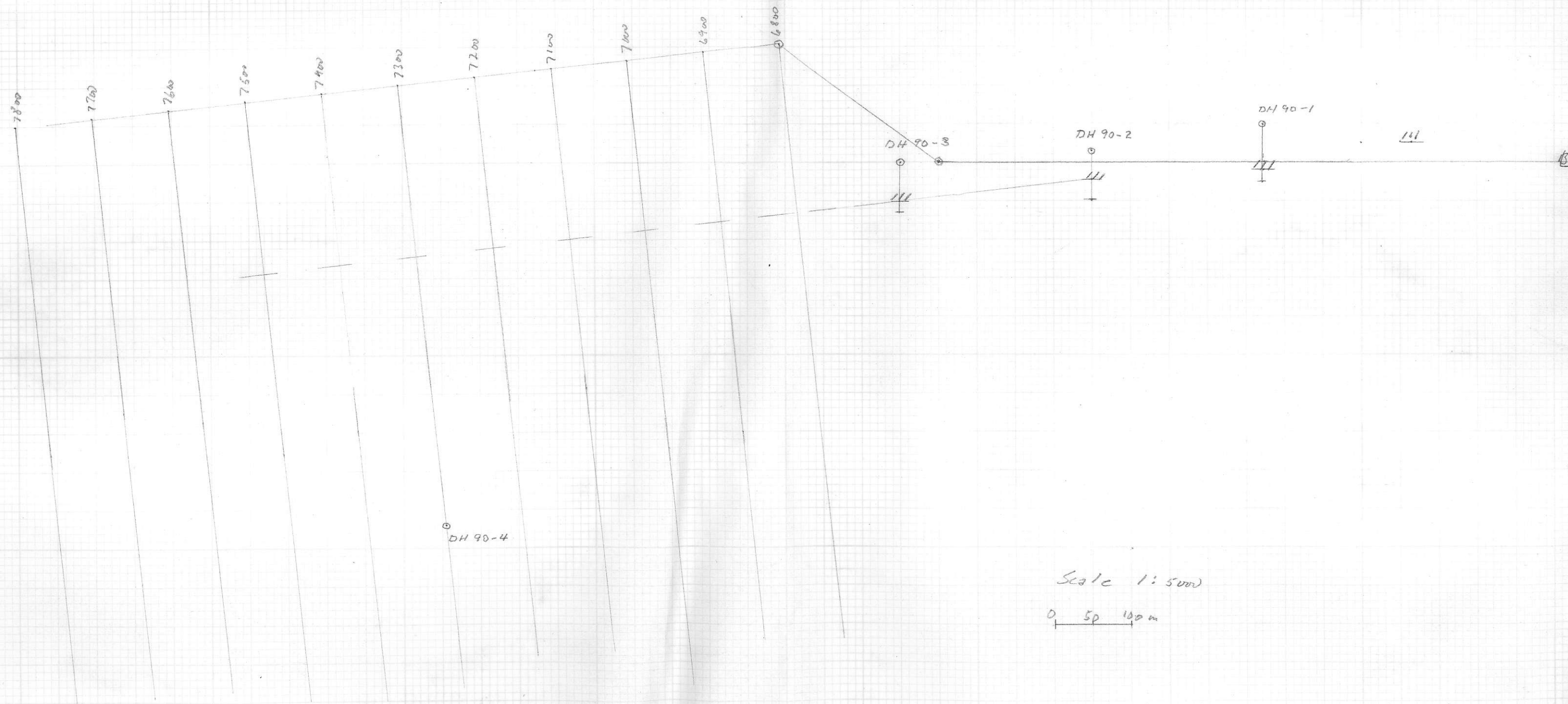

6700
 6600
 6500
 6400
 6300
 6200
 6100
 6000

W

9400 E

DDH 92-6 : 7700 N, 9400 E

E

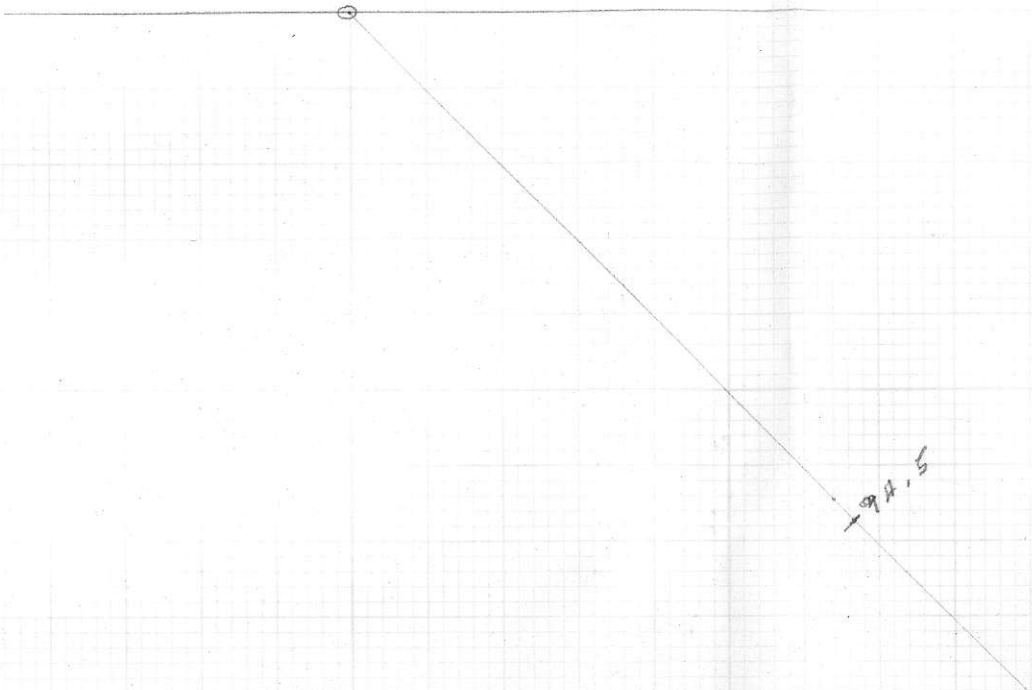

DDH 90-7.
SECTION 90+50N., 9450 E

(DRILL UNDER T90-22)

9470 - 9530

9447N
9048N

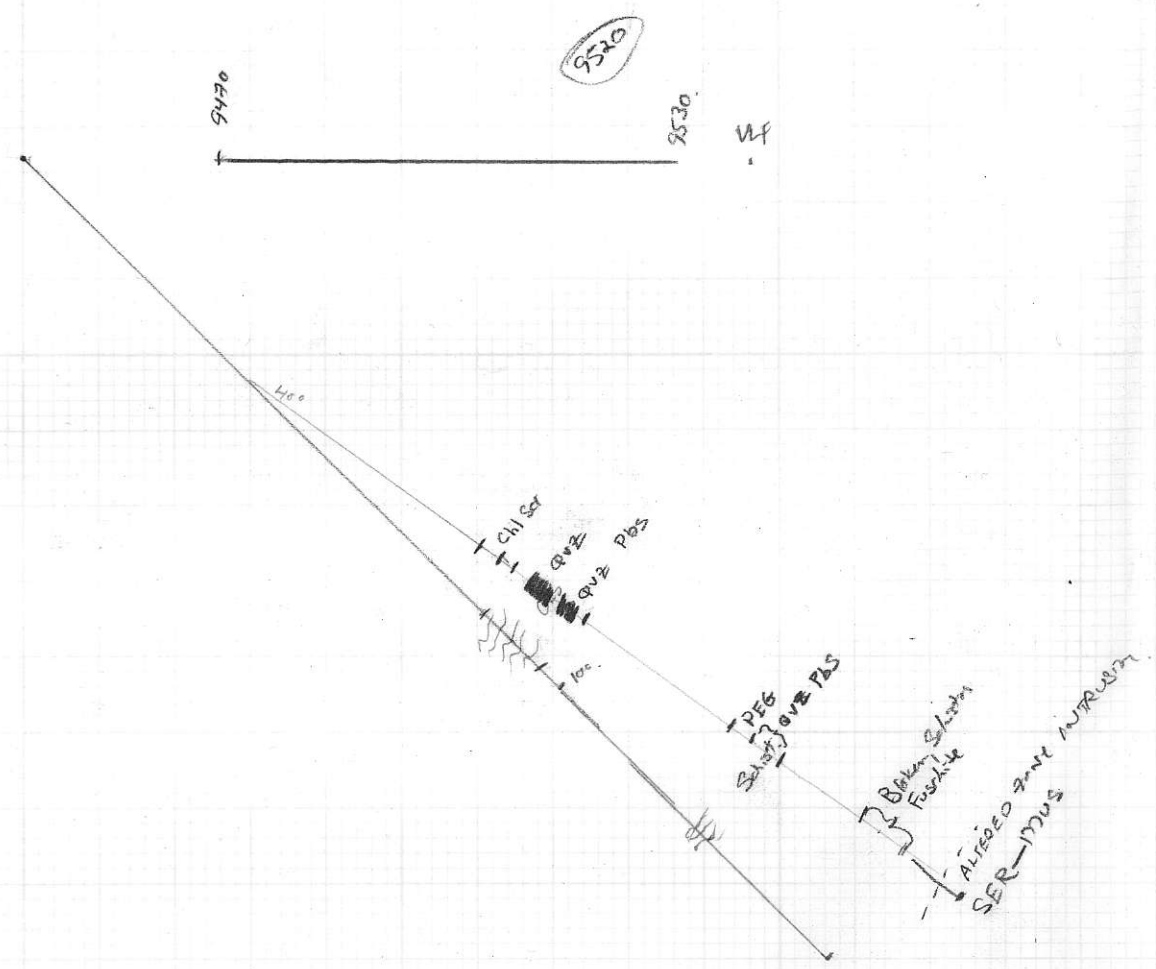

SECTION 9600N

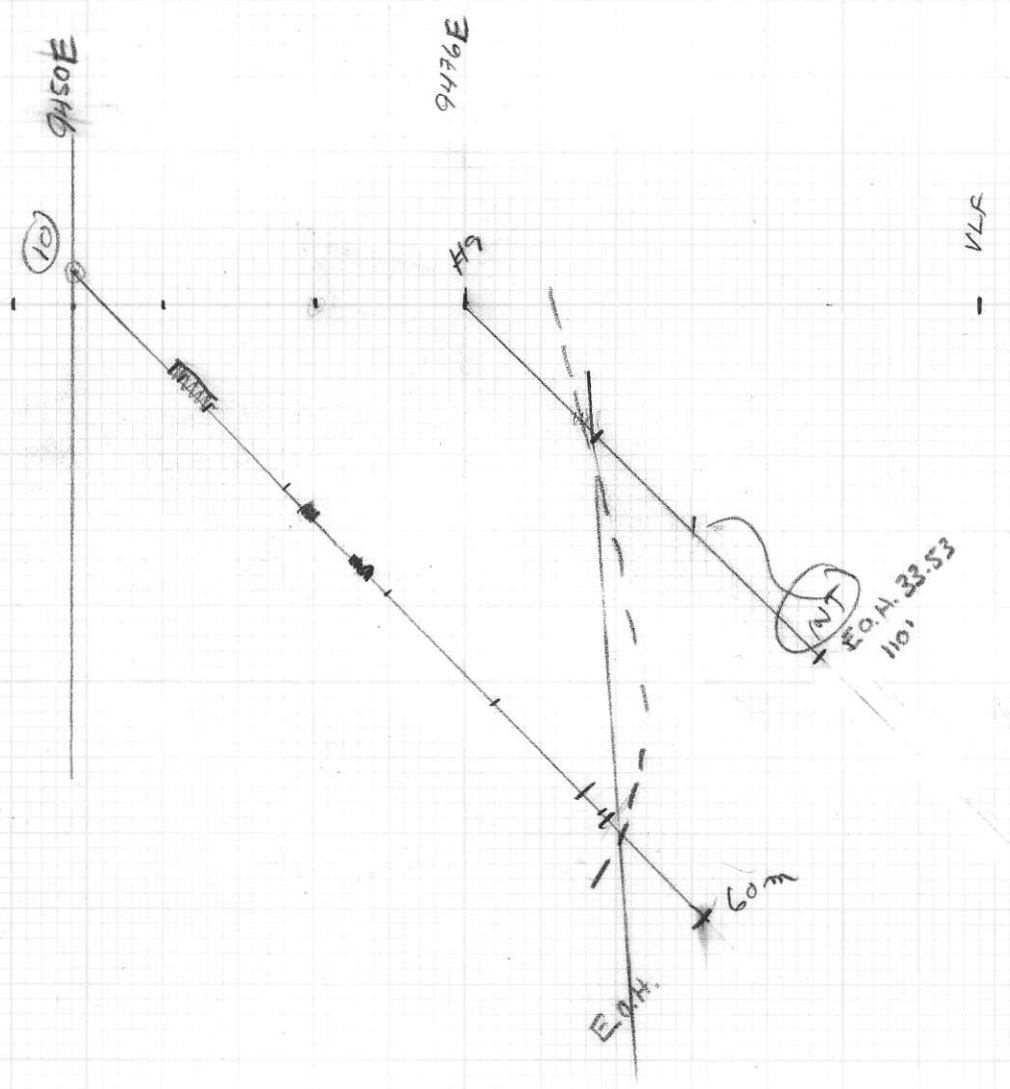

DRILLING
M/C CORNELL
M/C CORNELL
CREE
NORTH
303119
303119

