

NATION RIVER ZAP CHAIN GROUP SOIL AND SILT SAMPLING

SCALE
1:50,000 (1 MILE = 1.25 IN)

- LEGEND**
- ZAP CHAIN GROUP
 - SOIL SAMPLES
 - × SILT SAMPLES

841056

NATION RIVER; U-446

1" = 100'

JUNE 19 1977

G.L.

ROCK SAMPLE
LOCATIONS

GL-77-R16 - R24

U

Cu

Fig. 2B

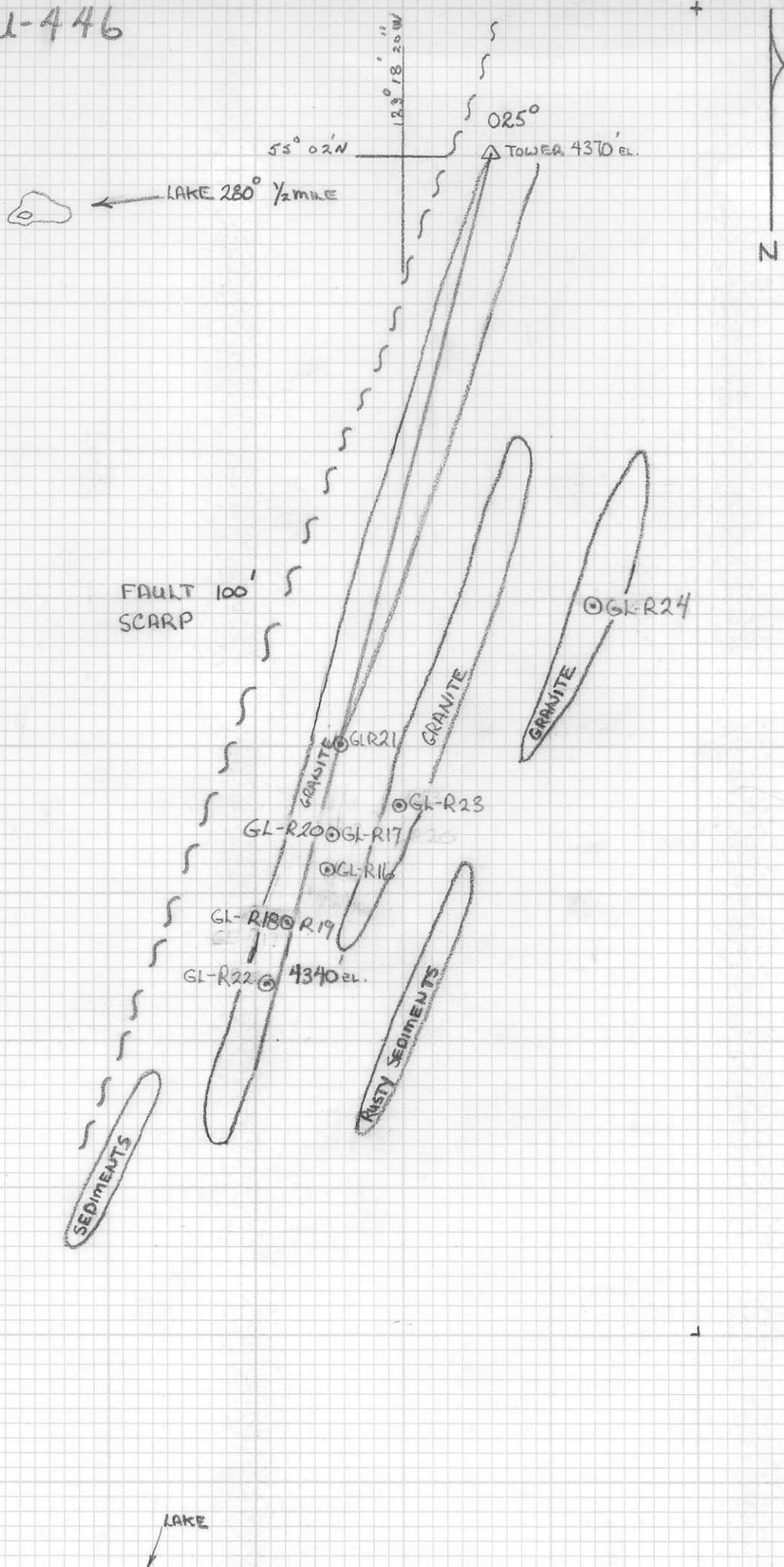

ROCK SAMPLE SITES

GL-77-R1 TO R10

U
MO
W PPM

1000 ft?
930/03W

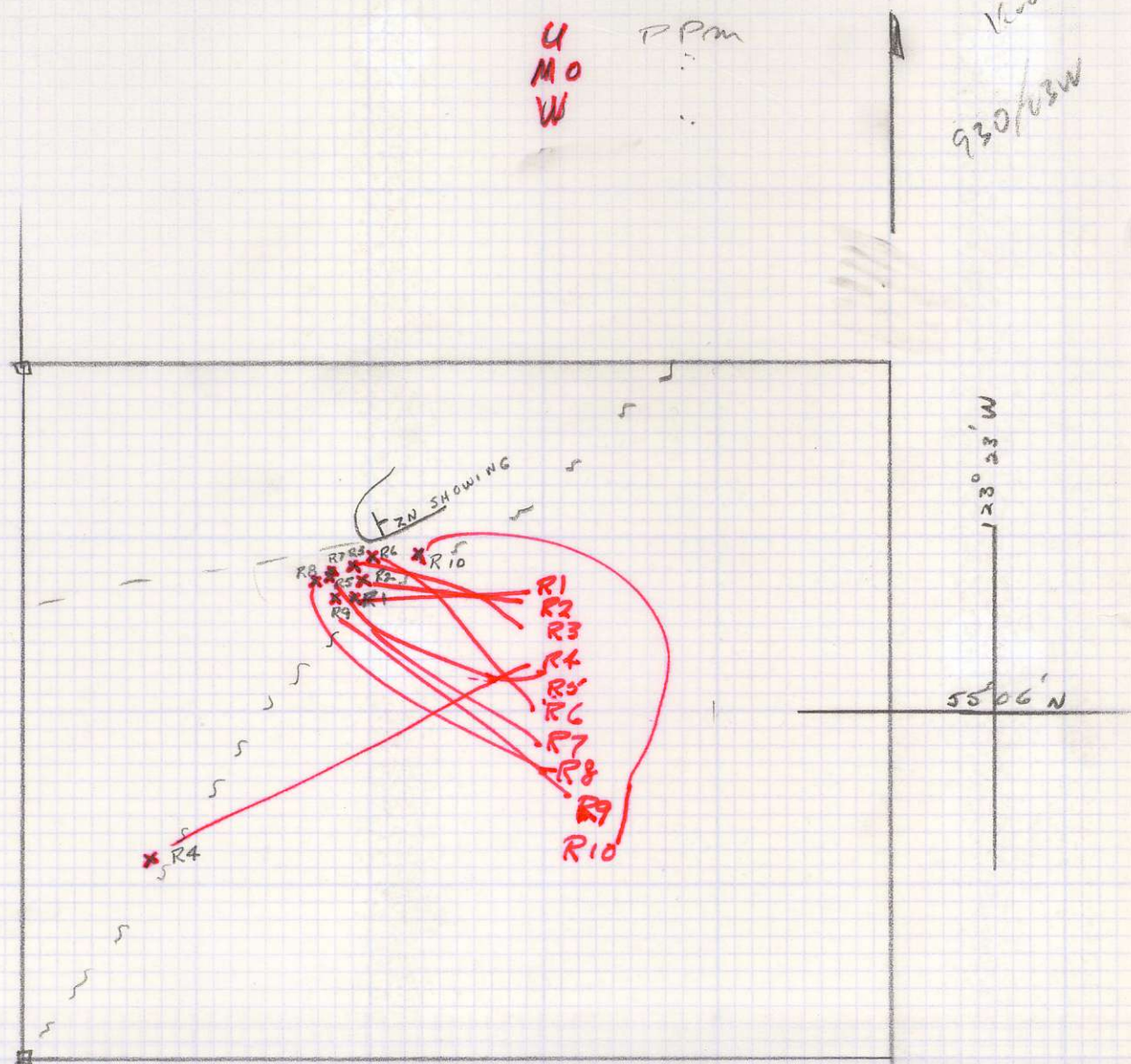

SCALE 1" = 100 METERS.

LECAL
CORNER
POST
ZAP MINING CLAIM

NATION RIVER; U 446

1 INCH = 250 METERS
 X SOIL SAMPLES
 • SILT SAMPLES
 □ CLAIM POSTS

SOIL SAMPLES
 SS = Soil
 S = Silt

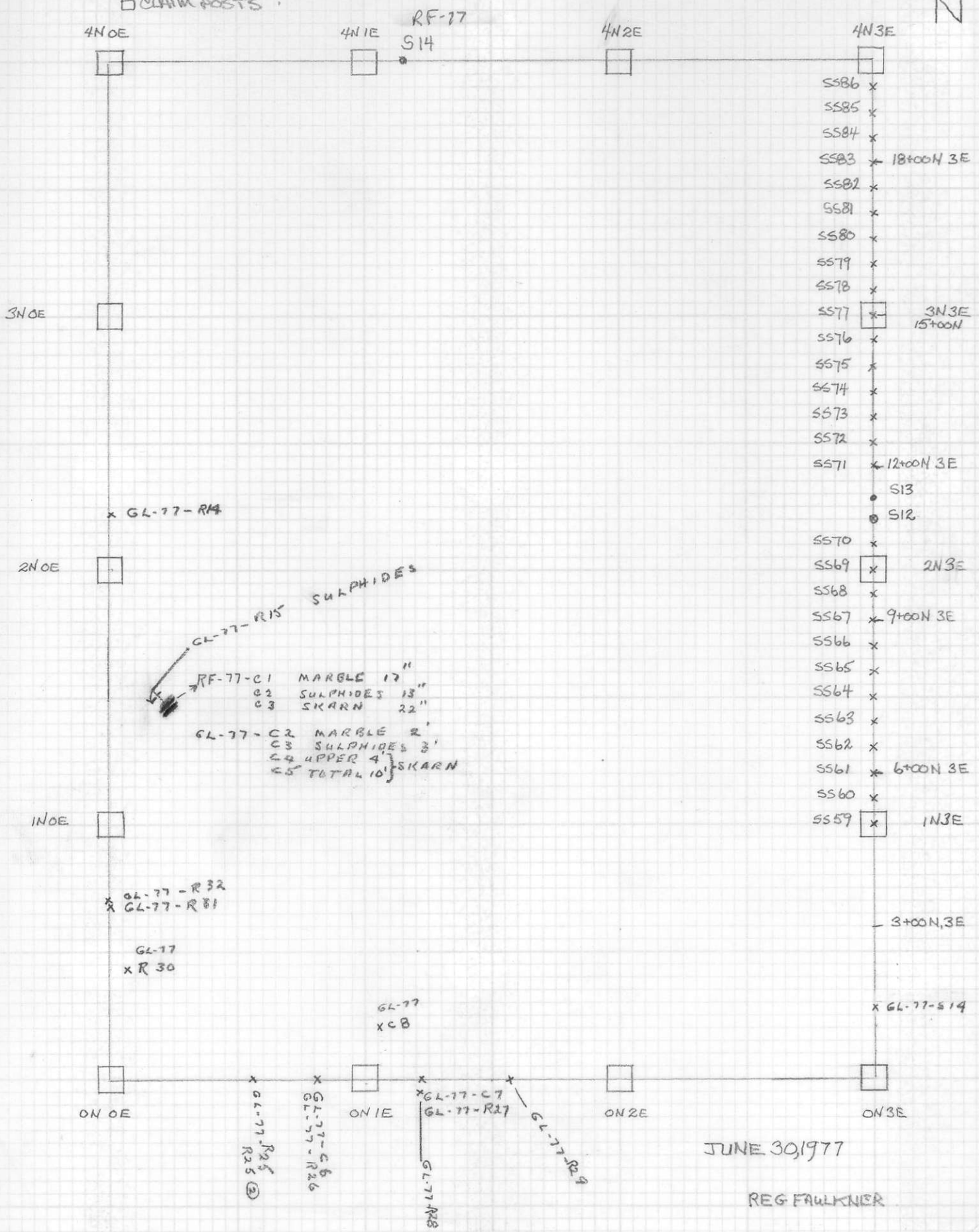

JUNE 30, 1977

REG FAULKNER

NATION RIVER

U446

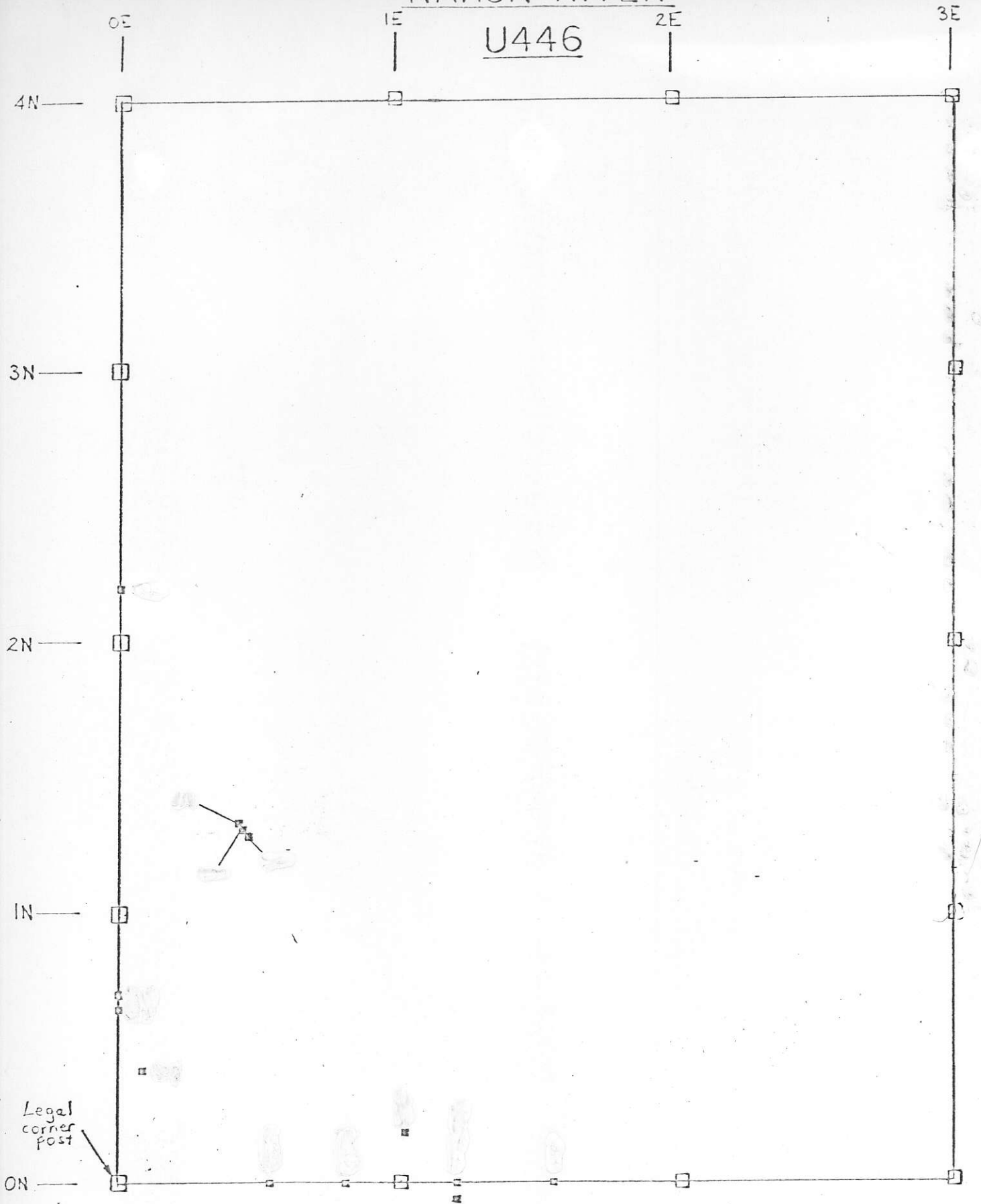

Legal corner post

- Soil
 - x SiH
 - Rock
- } Values in ppm

GEOCHEMISTRY



Figure 7E

G.M. Lafont
DEC 1977

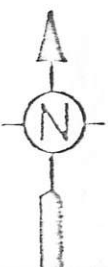

NATION RIVER

U446

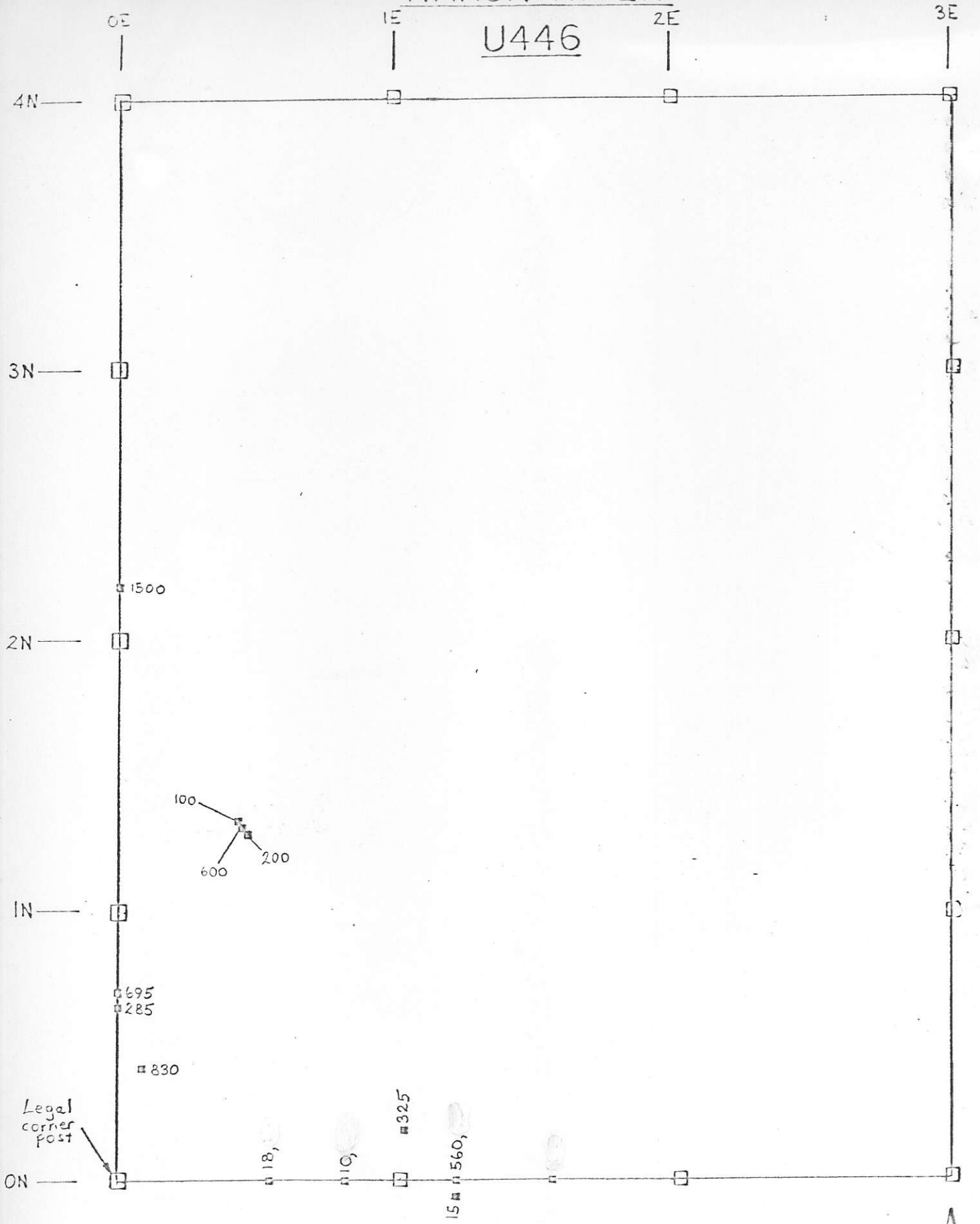

• Soil
 x Silt
 □ Rock

} Values in ppm

Cu GEOCHEMISTRY



Figure 7E

G. M. Lefors
 DEC 1977

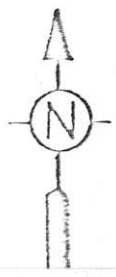

NATION RIVER

U446

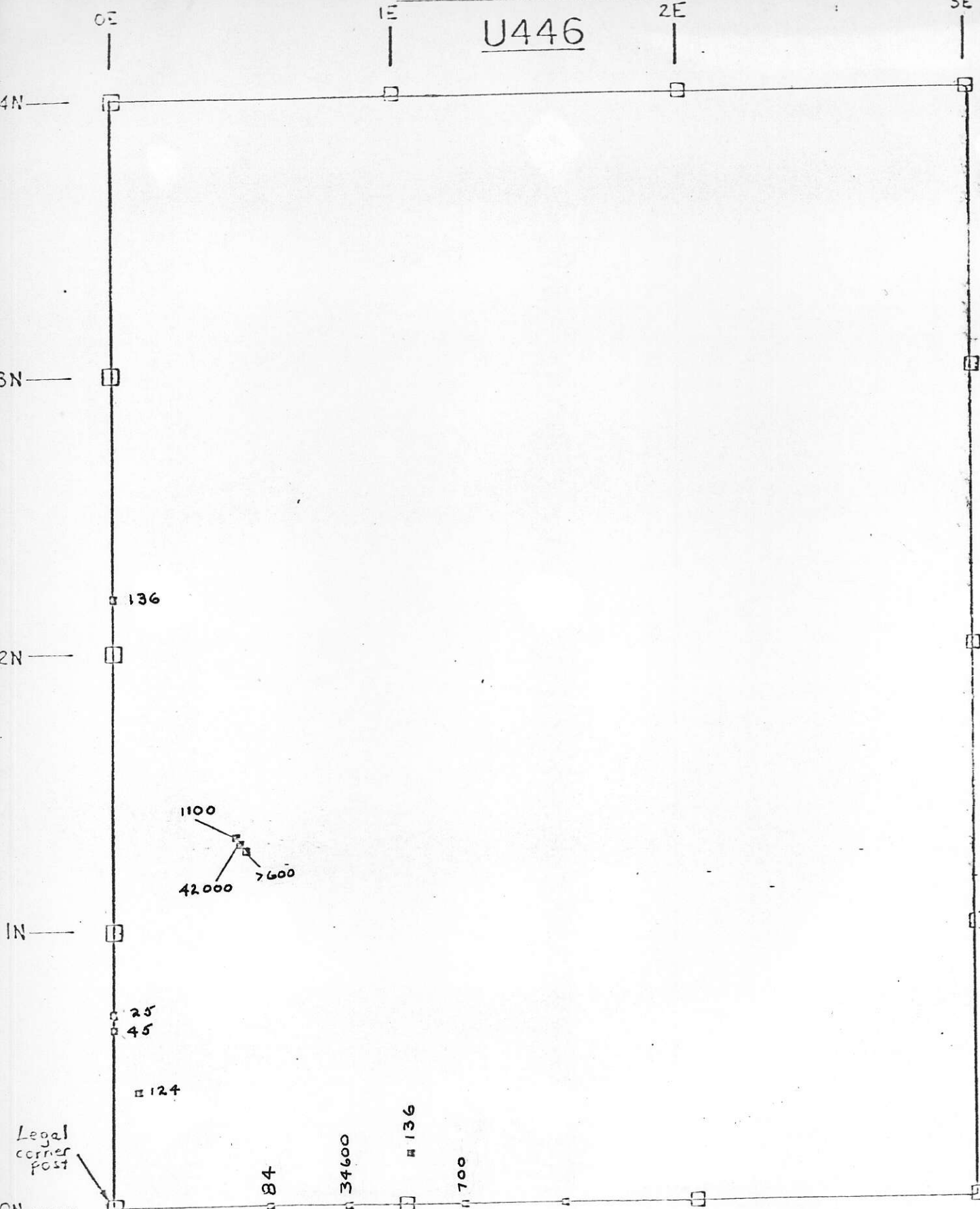

Legal corner post

• Soil
 x Soil
 □ Rock

values in ppm

Zn GEOCHEMISTRY



Figure 7E

Handwritten signature
 1977

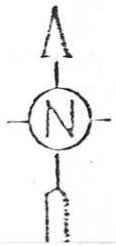

NATION RIVER

U446

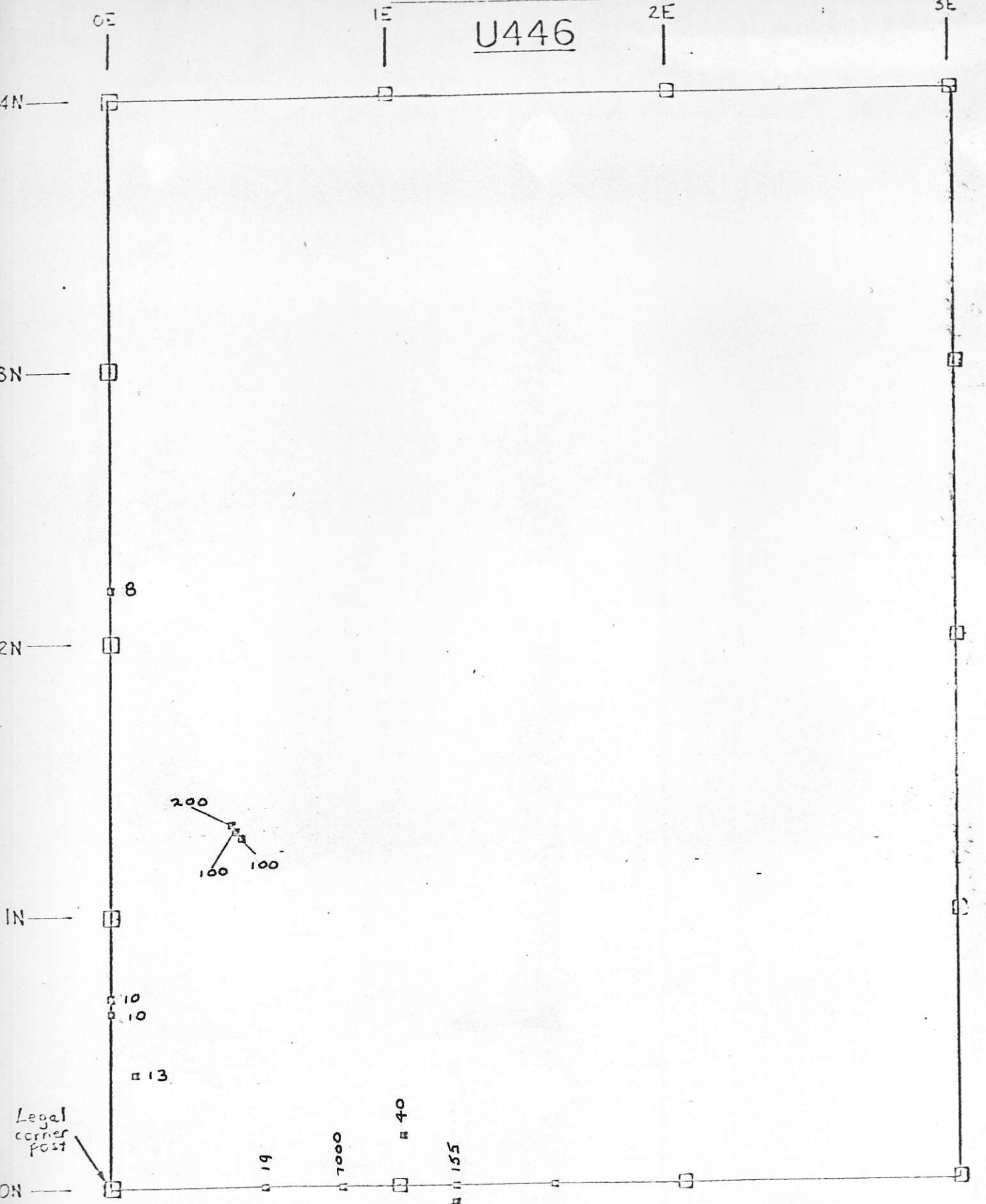

Pb GEOCHEMISTRY

Figure 7E

G. M. Johnson
 1977

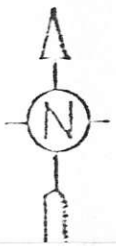

NATION RIVER

U446

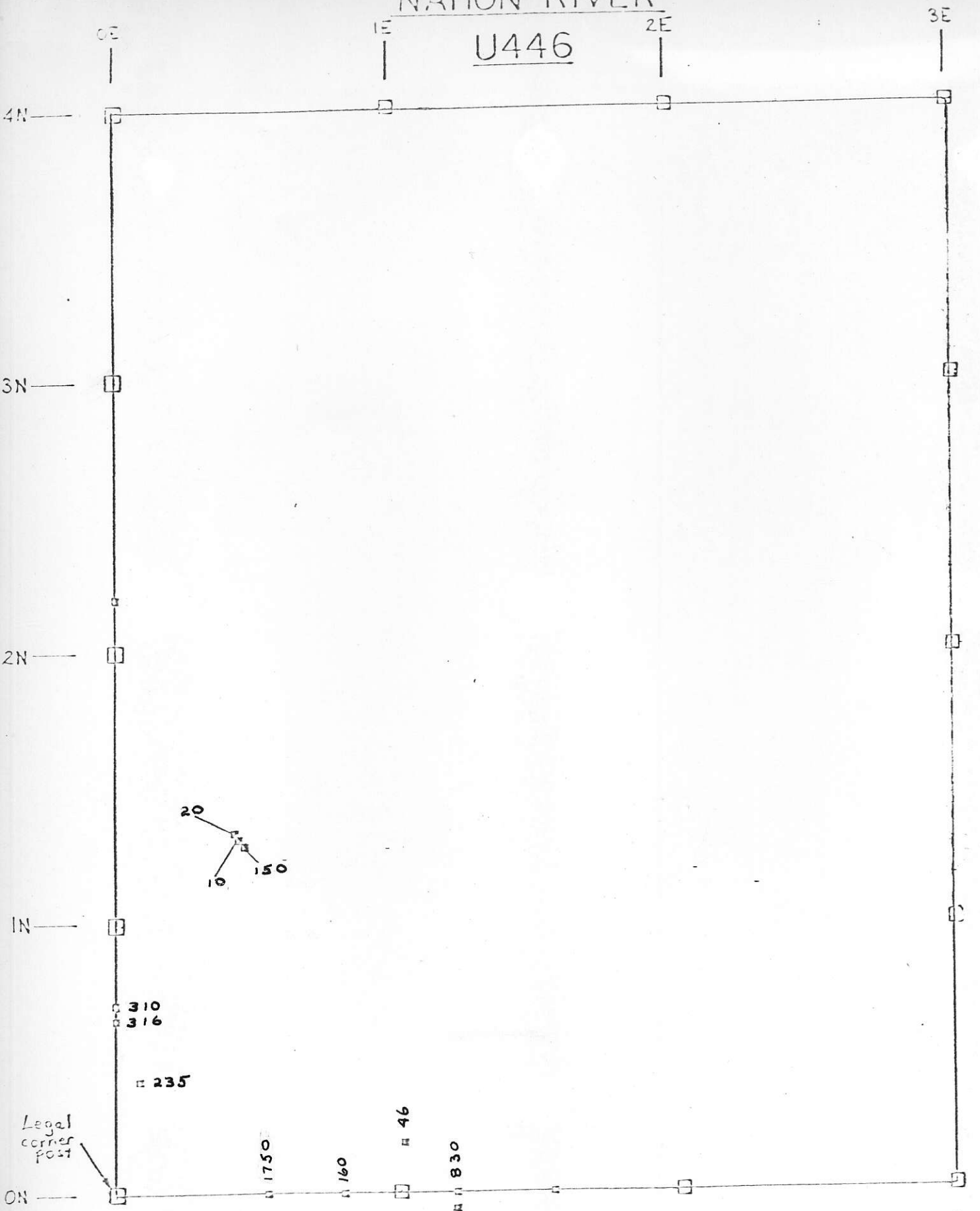

Mo GEOCHEMISTRY

• Soil
 x SiH
 □ Rock } Values in ppm

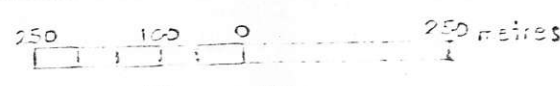

Figure 7E

Handwritten signature
 1977

